



A Donaldson Company

A WORLD LEADER IN FUME EXTRACTION TECHNOLOGY

DentalPRO Aerosol

DENTAL

Last Updated on 19.06.2020



The DentalPRO Aerosol helps to reduce risk of cross contamination between dental staff and the patient during examination.

With a market leading airflow to ensure optimum capture, it is designed to work alongside appropriate PPE guidelines. The DentalPRO Aerosol works by extracting contaminated air away from dental staff breathing zones and passing through a series of filters.

It is simple to use and maintain, and there's no need to vent outside as the filtered air is sent back into the room. Its three-stage filtration includes a HEPA filter which removes 99.997% of particles at 0.3 microns.

Due to the large adjustable flow rate, the DentalPRO Aerosol may be used for a variety of procedures between dental staff and patient and can be turned to maximum capacity for applications that involve heavier aerosol generation.

With a sleek design, this is an ideal addition to any dental setting, offering maximum protection and minimal interference.

Technology



DeepPleat pre filter



HEPA filter



Advanced carbon filter technology



Multi voltage sensing unit



ProTECT service plan



SureCHECK quality standard

Key features of the DentalPRO Aerosol

Three stage filtration - F8 Pre filter / HEPA / Gas filter
Standard

Low noise level
Standard

VOC Sensing (Volatile Organic Compound)
Optional

Complete with filter condition indicator
Standard

Digital air flow control
Standard

Contact BOFA at <https://bofainternational.com/en/contact/>

<https://bofainternational.com/en/portal/datasheets/dentalpro-aerosol/>







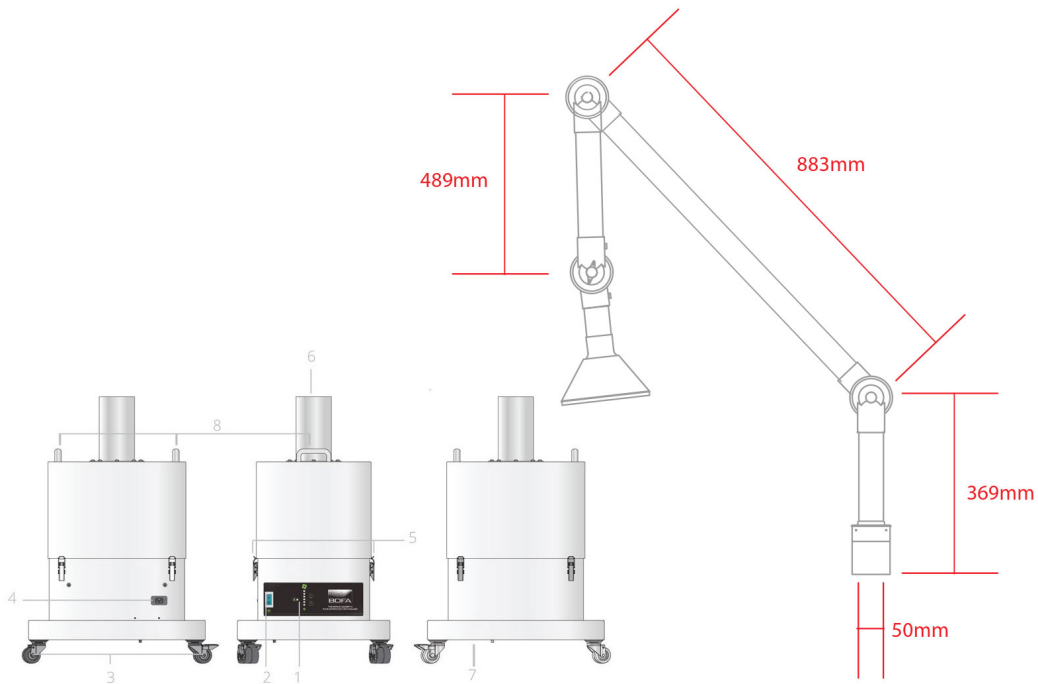

Technical specification

- 1. Unit / Filter condition display
- 2. On / Off switch
- 3. Castors
- 4. Power cable inlet
- 5. Filter housing latch
- 6. Arm inlet connection
- 7. Exhaust outlet
- 8. Handle



Airflow through filters

-  Chemical filter
-  HEPA filter
-  Pre filter
-  Clean air
-  Contaminated air
-  Particulate

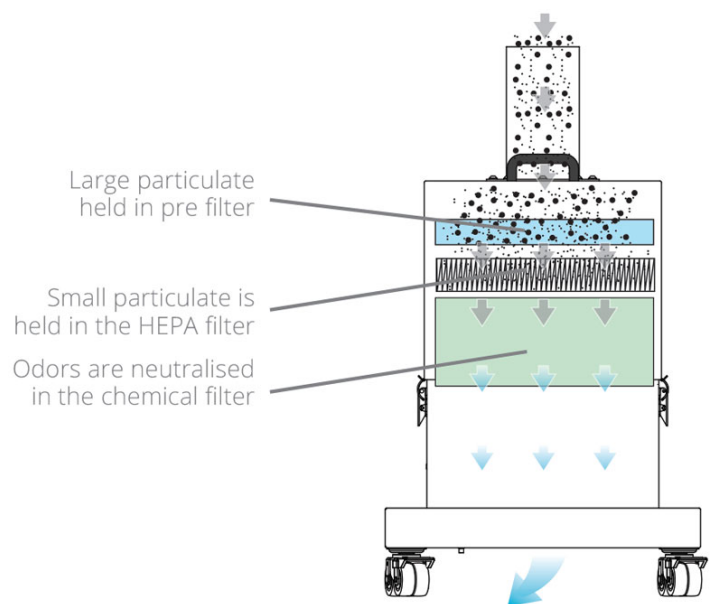

Technical data

	CE	US
Dimensions (HxWxD)	840 x 475 x 550mm (without arm / spigot)	33.07 x 18.70 x 21.65"
Cabinet construction	Powder coated mild steel	Powder coated mild steel
Blower	Centrifugal turbine	Centrifugal turbine
Airflow	240m ³ /hr	141cfm

Technical data

Electronics	90 - 257v 1ph 50/60Hz Full load current: 12.5 amps	90 - 257v 1ph 50/60Hz Full load current: 12.5 amps
Noise level	< 64dBA (at typical operating speed)	< 64dBA (at typical operating speed)
Weight	54kg	119lbs
Approvals	CE	CE

Pre filter specifications

Surface media area	8.25m ² approx (88.77 ft ²)
Filter media	Borosilicate
Filter media construction	Maxi pleat
Housing	Cardboard
Filter efficiency	95% @ 0.9 microns

Combined filter specifications

HEPA filter media	Maxi pleat
HEPA media construction	Pleated with glue bead spacers
Filter efficiency	99.997% @ 0.3 microns
Surface media area	3.5m ² (37.66 ft ²)
Treated activated carbon	12kgs (26.4 lbs)
Filter housing	Zintec mild steel

Unit part numbers

Model	Arm size	Part number
DentalPRO Aerosol	50mm	30351675-1127

Replacement filters

Description	Part number
Pre filter	A1030167
Combined filter	A1030166

Datasheet correct at time of publishing.

Where applicable, the carbon used in BOFA units is capable of removing a wide range of VOC's, however it is the responsibility of the user to ensure the carbon is suitable for their application. For specific applications, please contact us for details.

Think before you print! Please consider the environment before printing this document.

